



Learning Thermostat
Installation Guide

Compatibility

Nest works with over 95% of 24V heating and cooling systems, including gas, electric, oil, solar, hot water, geothermal, forced air, heat pump and radiant. It can control:

- Heating: one, two and three stages (W1, W2, W3)
- Cooling: one and two stages (Y1, Y2)
- Heat pump: with auxiliary and emergency heat (O/B, AUX, E)
- Fan (G)
- Power (C, Rh, Rc)
- Humidifier or dehumidifier (HUM, DEHUM)

Nest's ✪ connector can accept only one of these wires: W3, E, HUM or DEHUM.

Adding a common C wire is not required in 99% of installations.

- Professional installation recommended for:
- Dual fuel systems (heat pump with furnace)
 - Whole-home humidifiers and dehumidifiers

Go to nest.com/works to make sure Nest will work in your home and find out if you'll need Nest Concierge professional installation.

Watch the video

Before you install Nest, watch the installation video at nest.com/support

Questions? Visit support or give us a call at [855-4MY-NEST](tel:855-4MY-NEST).

Contents



Display

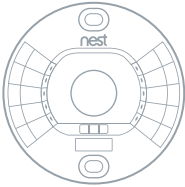

Base



Nest Screwdriver

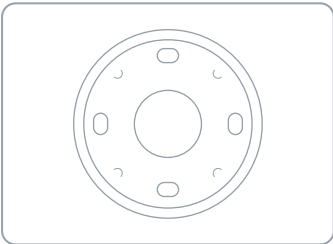

Optional Trim Plate

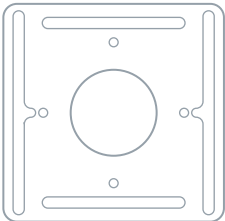

Optional Steel Plate



Wall Screws



Optional Steel Plate Screws

1. Switch off power

This protects you and avoids blowing a fuse. Adjust the temperature on your old thermostat to make sure your system is off.

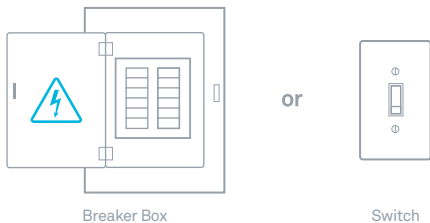

2. Remove cover

Some covers pop off, while others need to be unscrewed.

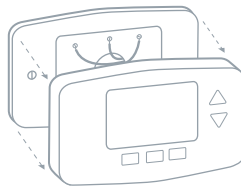

3. Check your system

If your old thermostat is labeled 120V or 240V or has thick wires with wire nuts, your system is high voltage. Not sure? Contact support.

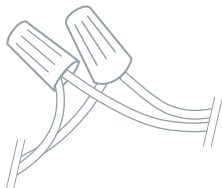

⚠ CAUTION: Do not connect Nest to high voltage wires.

4. Remove any jumper wires

Jumper wires are short wires between two connectors. Nest doesn't need them. An R wire can go into either Rc or Rh.

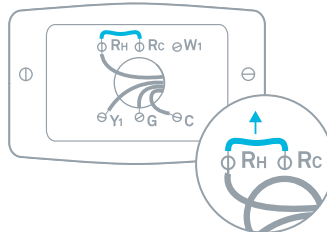

5. Label wires

Peel off the blue labels and attach them to your wires. Use the white labels if you have a E, W3, HUM or DEHUM wire. You can connect only one of these wires to Nest's ★ connector.

HUM and DEHUM wires may require a professional. Check at nest.com/works

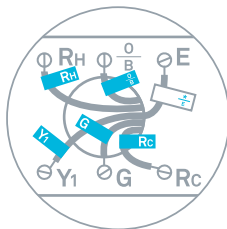

Tip: Take a picture of the wires on your old thermostat to help you remember.

6. Disconnect wires and remove base

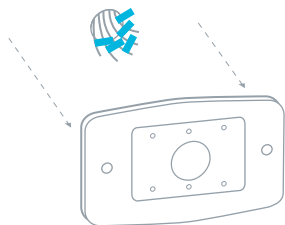

Tip: Wrap the wires around a pencil to keep them from falling into the wall.

7. Mark where screws will go

Use the bubble level to make sure Nest is level.

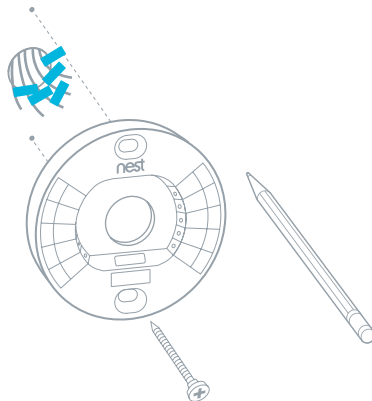

Optional in most homes

Use trim plate if needed

You can cover up holes or marks left by your old thermostat with the optional trim plate.

Place the trim plate on the wall and put the base on top so they snap together, then screw them both to the wall.

The trim plate can be found in the bottom of the Nest box.

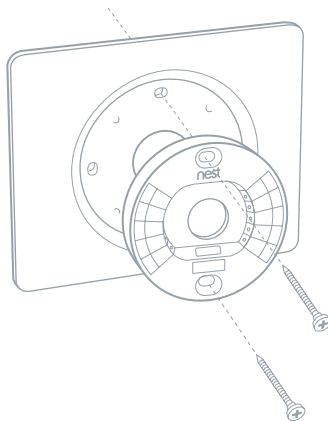

Optional in most homes

Mounting Nest on an electrical box

Electrical boxes aren't common, but if you have one, secure the steel plate to the electrical box with two of the short steel plate screws. Insert the screws into the long slots on the steel plate.

Use the other two short screws to attach the Nest base and trim plate to the steel plate.

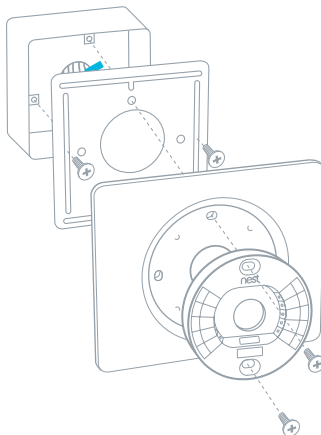

8. Attach base

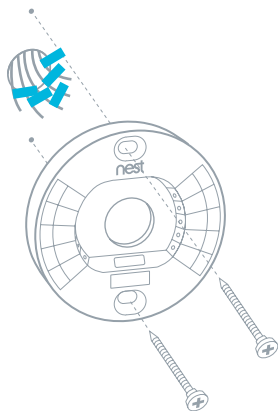

9. Connect wires

After all the wires are connected, make sure they're flush with the wall.

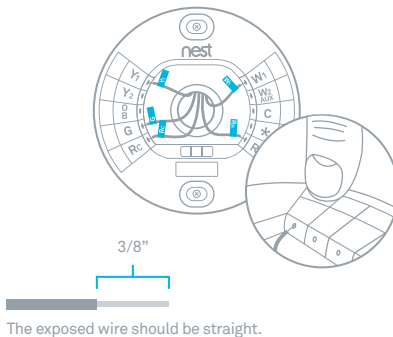

10. Attach display

Press the display until it clicks into place.

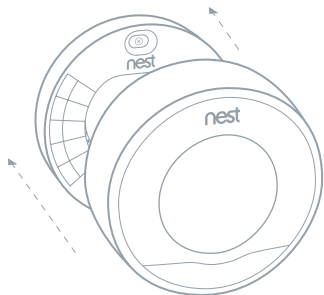

11. Switch power back on

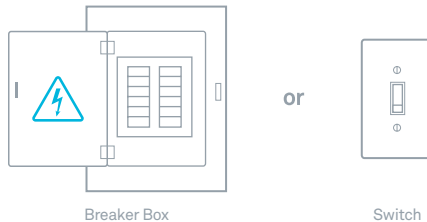

12. Setup and Nest Account

Nest will turn on and walk you through setup. Turn the ring and press to select.

Connect Nest to Wi-Fi during setup, then visit nest.com/account to create a Nest Account so you can control Nest from anywhere.



For more information visit nest.com or call [855-4MY-NEST \(855-469-6378\)](tel:855-4MY-NEST).



Recycle your old thermostat: see nest.com/responsibility

Please recycle Nest's 100% recyclable packaging.